

DIGITAL INDUSTRIES SOFTWARE

# Simcenter Femap 2022.2

Powerful, collaborative simulation

## Benefits

- Facilitate collaboration with colleagues, suppliers, partners, and customers
- Create a fully connected hex mesh without geometry cleanup
- Streamline the creation and editing of complex layouts
- Accurately assemble with moving parts

## Summary

Simcenter™ Femap™ software is an advanced finite element modeling (FEM) software application used as a pre- and post-processor for engineering simulation and analysis. Advanced workflows in Simcenter Femap enable analysts to model components, assemblies, and systems, and digitally analyze a model's response under real-world conditions.

**SIEMENS**

[siemens.com/simcenter-femap](https://www.siemens.com/simcenter-femap)

**Features**

- Next-generation cloud collaboration with Xcelerator Share
- Automated hex-dominant meshing
- Laminate improvements
- New Kinematic Joints and Flexible Sliders simulation entities
- Support for aeroelastic response in Simcenter NASTRAN®

Simcenter Femap provides engineering organizations with powerful data-driven and graphical results visualization and evaluation capabilities. Combined with the integrated Simcenter NASTRAN™ solver, Femap delivers a comprehensive solution for engineering simulation.







For more than 30 years, Simcenter Femap has provided an industry-leading solution to accurately model and simulate structural, dynamic, and thermal performance of complex engineered systems. Simcenter Femap 2022.2 continues this tradition with new features and enhancements to improve FEA productivity and accelerate collaboration.



**Next-generation cloud collaboration with Xcelerator Share**

Complex problems require effective collaboration. Cloud-based software can remove hurdles standing in the way of finding a solution. You can now instantly, securely, and easily collaborate with colleagues, partners and customers with Siemens’ next-generation, cloud-based collaboration solution, Xcelerator Share – now available in Simcenter Femap 2022.

Xcelerator Share and Simcenter Femap offer a wide range of collaboration features. Share’s rich set of capabilities addresses your cloud collaboration needs by providing teams with secure, central storage with optional data management tools. It also enables ad-hoc collaboration with internal and external stakeholders, thanks to easy email address-based project and file sharing.

- |   |   |
|---|---|
|  Secure cloud storage                |  Augmented Reality (AR)        |
|  Desktop file syncing                |  Messaging and notifications   |
|  Permission-based project sharing    |  Any device, instant-on access |
|  Engineering-centric view and markup |   |

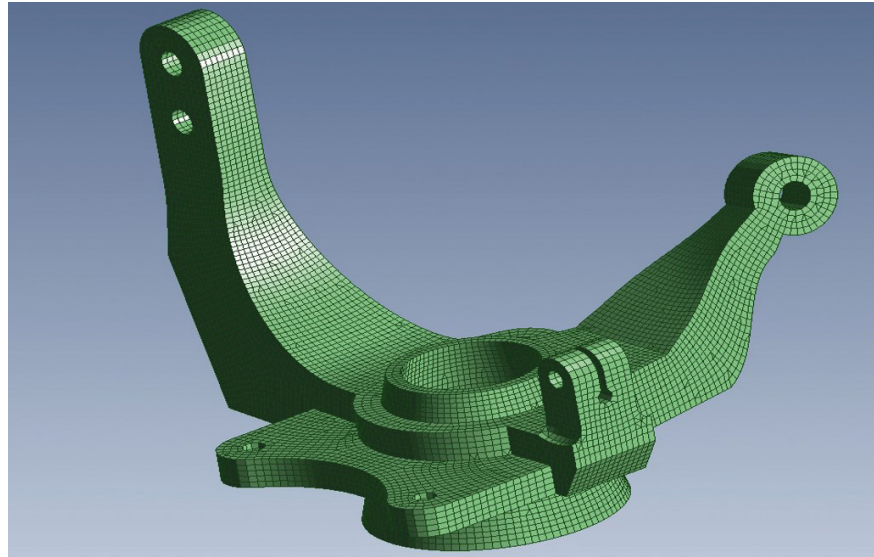

### **Automated hex-dominant meshing**

The Hex-Dominant Mesher creates as many Hexahedral elements as possible then fills the rest of the volume with Wedge, Pyramid, and Tetrahedral elements if you are simply looking for another sentence. When using the default value for Target Mesh Size, this typically results with over 85% of the volume being meshed with hex elements. Simcenter Femap 2022.2 eliminates the need for extensive geometry cleanup and manipulation, which is typically required to create a fully connected hex mesh.

With the introduction of automated hex-dominant meshing using the Mesh, Hex Mesh Bodies command, Simcenter Femap delivers a meshing tools that streamlines the process of creating of a high-quality hex-dominant mesh.

Unlike legacy geometry splitting, hex-dominant meshing of solid geometry in Simcenter Femap now requires little to no simplification or subdivision into smaller and simpler regions. This is a capability that has long been desired by the FEA community.

**Laminate improvements**

**Ply Material Manager**

A new entity type, Ply Material, is managed via the Ply Material Manager. A Ply Material is a predefined ply used to ensure Thickness, Material, and Failure Theory. In the Layup Manager, Ply Type can be set to Ply Material then any existing Ply Material can be referenced.

Engineers use composite materials to make product designs stronger and lighter. Simcenter Femap 2022.2 includes enhanced functionality that streamlines the creation and editing of complex layups.

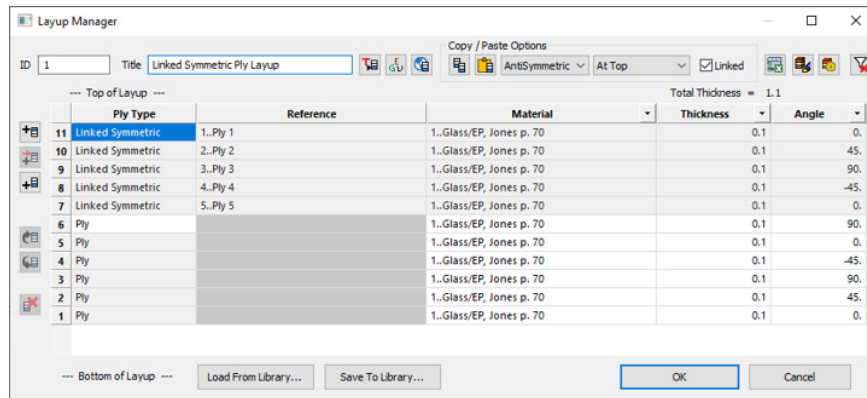

**Layup Manager**

The Layup Manager now offers a user-friendly grid, similar to a Microsoft Excel spreadsheet, making it significantly easier to create and edit layups. Data reuse is now encouraged with standard reference plies, and with the ability to re-use existing layups within other layups.

**Multi-Layup Editor**

A new Multi-Layup Editor has been added that allows multiple layups to be viewed side-by-side to assist in adding, deleting, and inserting plies, and assigning Global Ply IDs. These new additions are all connected, making it easier to effect bulk changes across multiple layups.

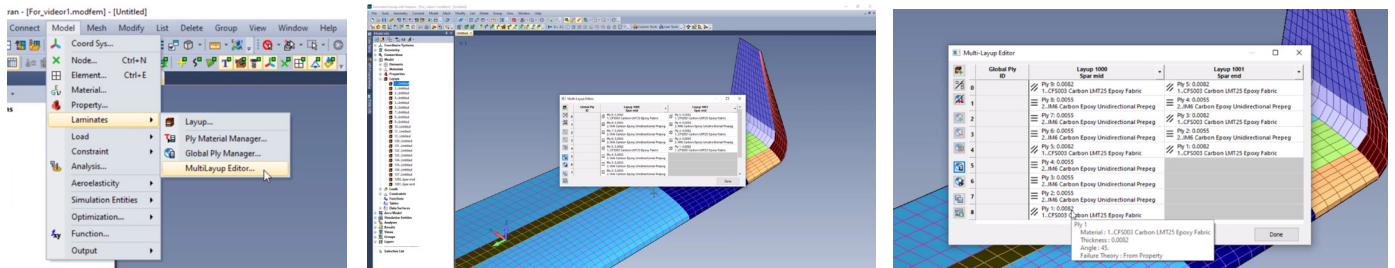



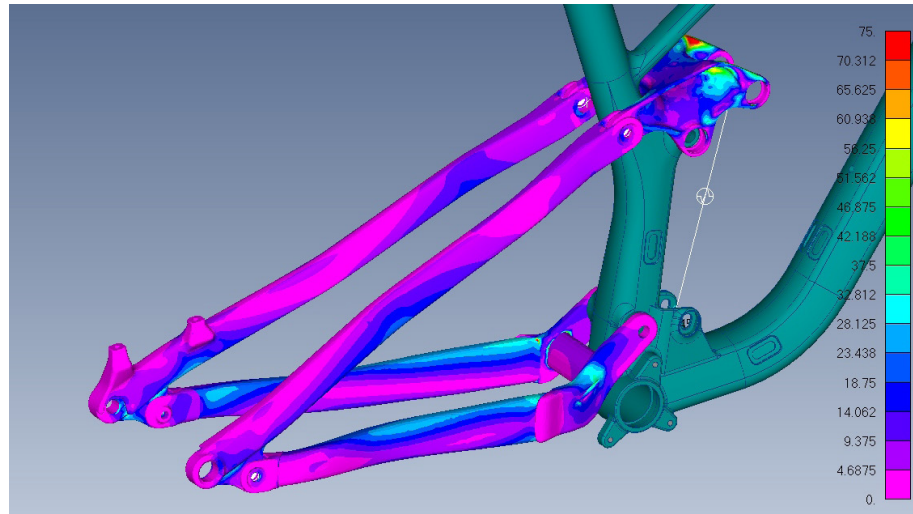

### New simulation entities

New simulation entities in Simcenter Femap 2022 help improve representation of real-world conditions when simulating assemblies with moving parts. Kinematic Joints and Joint Connections can be used with certain solution sequences in Simcenter Nastran or ANSYS.

Kinematic Joints have been added as simulation entities in Simcenter Femap 2022.1, providing support for advanced simulation methods, such as flexible body dynamics. Available joint types to define include revolute, spherical, universal, various slider types, and many more. Joint-specific boundary conditions have also been added to provide more control over the joint during the analysis. They can be loaded with various types of drivers including force, torque, imposed displacement, and imposed rotation. Using the joint time constraint, joints can also be freed or constrained during specific times in the analysis.

In addition, support for the Element Results Monitor Point (MONPNT2) for Simcenter Nastran and MSC Nastran has also been added.

### Kinematic Joints

Kinematic Joints have been added as simulation entities in Simcenter Femap 2022.1, providing support for advanced simulation methods, such as flexible body dynamics.

### Joint Connections

To accelerate the process of creating kinematic joints, Joint Connections have been added as a new unique entity type, allowing users to establish how a kinematic joint will be connected to geometric entities or an existing mesh.

### Flexible Sliders

Expanded support has been added for kinematic analysis of mechanical systems with the addition of Flexible Slider simulation entities. Flexible Sliders allow analysts to accurately simulate the deformation of curvilinear tracks as assembly components move along them.

## User interface enhancements

### Line element offsets

Workflow for applying and updating line element offsets has been streamlined by consolidating the user interface.

### Grouping and selection methods

Geometric entities can now be added to groups by selecting nodes or elements associated to them. In addition, new methods have been added to simply select geometric entities by selecting associated nodes or elements. Finally, specially-coded API scrips can now be called to select entities from the standard entity selection dialog box.

### Analysis set manager

Find functionality in Preview Analysis Input File dialog box has been added to search previewed input for text.

In addition, it is now possible to specify the number of tasks when using Distributed Parallel Processing (DMP) for Simcenter Nastran.

### Modern online help system

Originally implemented for v2022.1, a modern HTML Help System available online has been improved and more content is now available.

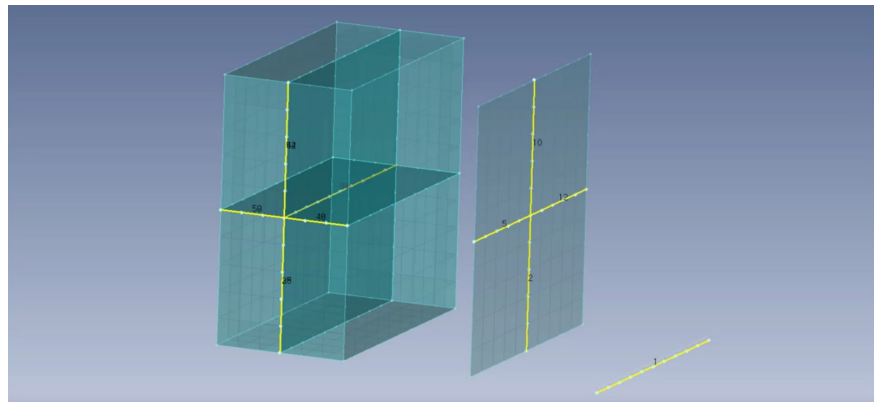

### Support for aeroelastic response in Simcenter NASTRAN®

Simcenter Femap 2022.2 provides support for aeroelastic dynamic frequency, transient, and random response in addition to its long-standing support for static aeroelasticity and aeroelastic flutter. These capabilities are powered by the integrated Simcenter NASTRAN solver and are compatible with other versions of Nastran which offer SOL 146.

#### Frequency and transient response

Offers the ability to perform modal frequency response or modal transient response which involve aeroelastic entities, such as bodies, splines, and control surfaces along with adding the ability to specify a vertical gust load on the entire structure.

#### Random response

Supports the same new inputs which allow frequency and transient response to be performed in SOL 146 and allows for input of solution-specific power spectral density values designed specifically for analysis involving gust.

Supports the same new inputs which allow frequency and transient response to be performed in SOL 146 and allows for input of solution-specific power spectral density values designed specifically for analysis involving gust, including Simcenter NASTRAN's built in von Karman and Dryden spectrum. In addition, non-standard gust PSD inputs can also be specified with traditional tabular power spectrums.

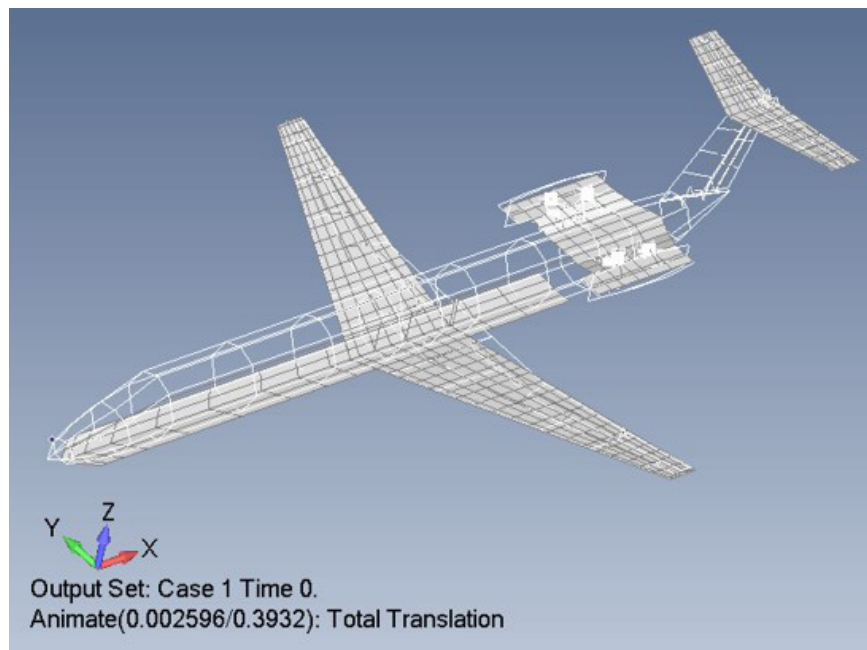

**Xcelerator as a Service (XaaS) and Simcenter Femap**

Imagine a company that collaborates with its suppliers, vendors, partners, and customers; where all engineers work simultaneously on the next product launch; a company that scales as it grows. This company is now a possibility – with Xcelerator as a Service (XaaS) offerings. XaaS provides unprecedented access to the cloud and is scalable and flexible to meet specific business needs.

Xcelerator Share, Siemens’ next-generation cloud-based collaboration solution – now available in Simcenter Femap 2022 – is the first cloud component of our new XaaS subscriptions.



**Xcelerator as a Service**

Software as a Service enables the power of Xcelerator in a more accessible, scalable and flexible form.

- Comprehensive Digital Twin
- Personalized Adaptable/Modern
- Flexible Open Ecosystem

**So what are “XaaS” subscriptions?**















Siemens and its customers are facilitating digital transformation with Xcelerator as a Service. We’re expanding the Xcelerator software and services portfolio to include the transformative capabilities provided by the cloud, further enhancing collaboration and cross-domain capabilities, with new functionality being added over time.



**Simcenter Femap vs. Simcenter Femap XaaS**

Simcenter Femap XaaS delivers everything that our customers already know and love about Simcenter Femap, with the value-added benefits of cloud services through a XaaS subscription offer – making Simcenter Femap more accessible, flexible, and scalable for teams and companies of all sizes.

Simcenter Femap XaaS is not a replacement of the standalone Simcenter Femap product. Instead, it is an opportunity to take advantage of a new cloud-based collaboration capabilities through a flexible subscription. With the introduction of Xcelerator as a Service, Simcenter Femap is available to purchase in two different ways: the standalone Simcenter Femap product, or the Simcenter Femap XaaS subscription which includes the full version of Simcenter Femap and the benefits of cloud collaboration with Xcelerator Share. The choice is yours.

Simcenter Femap		Simcenter Femap XaaS			
 Structures	 dynamics	 Structures	 dynamics	 Mission-critical collaboration	 Cross domain collaboration
 Motion	 Thermal- flow	 Motion	 Thermal- flow	 Data management	 Security
				 Scalable to Teamcenter PLM (Jan 2023)	 Secure cloud storage

**Siemens Digital Industries Software**  
[siemens.com/software](https://www.siemens.com/software)

Americas  
 1 800 498 5351

Europe  
 00 800 70002222

Asia-Pacific  
 001 800 03061910

For additional numbers, click [here](#).